

VERSÃO V3
SETEMBRO 2023

FULL SPECTRUM LED STRIPS

CRI 97

MacADAMS 3

ADESIVO 3M VHB 4929 IP65

5 ANOS GARANTIA

EFICIÊNCIA

ATÉ 150 Lm / W



COMPONENTES

FITAS LED

C.1



RELATÓRIO FOTOMÉTRICO

Estão disponíveis relatórios fotométricos completos para todas as referências de fitas Led, bem como ficheiros .IES e .LTD para os programas de projecto luminotécnico.

NEXT LIGHT Color Bin Definitions

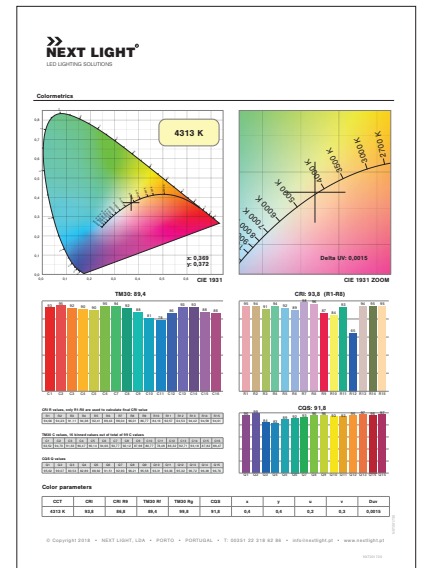
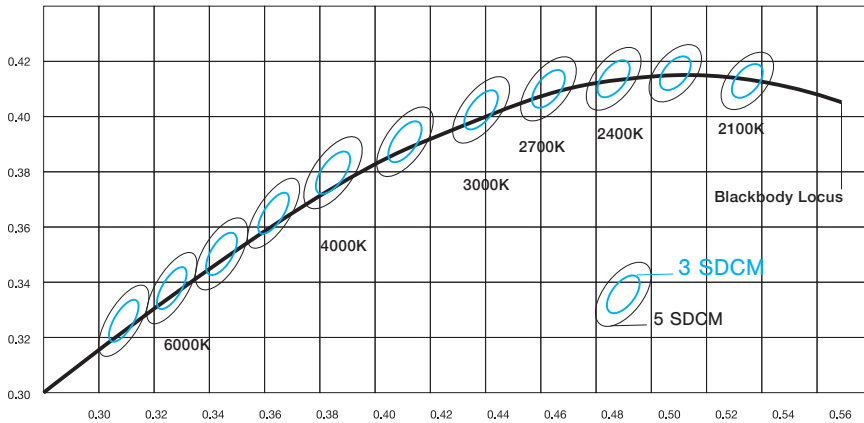

5 METROS IP20
Ø 130mm x 14mm



5 METROS IP65
Ø 190mm x 20mm

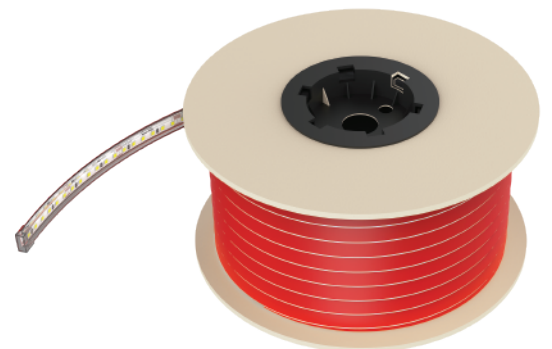

50 METROS FITA AC

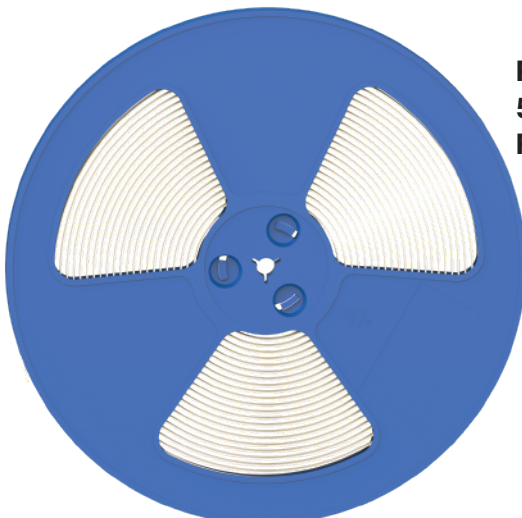

**PROFESSIONAL
50 METERS
REELS IP20**

25 METROS IP65

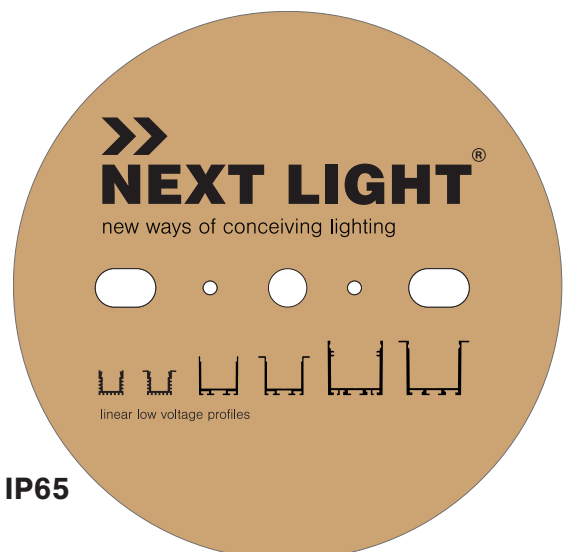

linear low voltage profiles

C.1

COMPONENTES FITAS LED

Constant voltage Strip

5 mm CHIP ON FLEXIBLE PCB

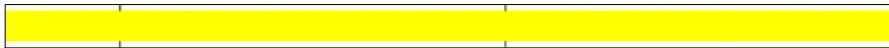

2110 24VDC

8W

LEDs/M MIN CUT FPCB
528 45.2 mm 5 mm

2700 K 3000 K 4000 K

Lm CRI
900 / m 93



8 mm CHIP ON FLEXIBLE PCB

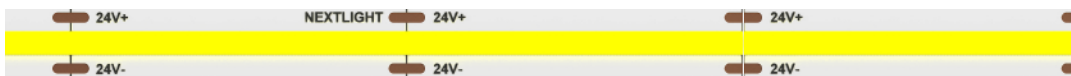

2110 24VDC

10W

LEDs/M MIN CUT FPCB
480 50 mm 8 mm

2700 K 3000 K 4000 K

Lm CRI
1100 / m 93



4MM PCB: **238 LED/MT >100 LM/W**



2110 24VDC

12W

LEDs/M MIN CUT FPCB
238 29.4 mm 4 mm

2700 K 3000 K 4000 K

Lm CRI
1100 / m 94



C.1

COMPONENTES FITAS LED



2835 24VDC

5W

LEDs/M
64

MIN CUT
125 mm

FPCB
8 mm

2700
K

3000
K

4000
K

Lm
550 / m

CRI
95



2835 24VDC

10W

LEDs/M
128

MIN CUT
62.5 mm

FPCB
8 mm

2700
K

3000
K

4000
K

Lm
1100 / m

CRI
97



2835 24VDC

14W

LEDs/M
160

MIN CUT
50 mm

FPCB
10 mm

2700
K

3000
K

4000
K

Lm
1910 / m

CRI
97



TUNNABLE WHITE: **192LED/MT > 17W**

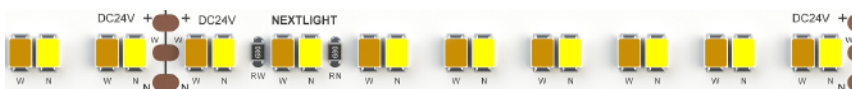

2835 24VDC

17W

LEDs/M
192

MIN CUT
83,3 mm

FPCB
10 mm

2700
K

6500
K

Lm
1100 / m

CRI
94



C.1

COMPONENTES

FITAS LED

RGB NEW 4040 LED : 120 LEDS / METER



4040 24VDC

16W

LEDs/M 120
MIN CUT 50 mm
FPCB 6 mm



Light Color	Color Temperature/Wavelength(K/nm)	Beam Angle	Ra	Typical Luminous Flux(lm/m)	Efficacy (lm/w)	Voltage (DC V)	Power (W/m)
R	615-630	120°	--	169	33	24	5.2
G	515-530			307	60		5.2
B	460-470			64	12.4		5.2
RGB				492	32		15.6

RGB NEW 4040 LED : 56 LEDS / METER BOBINE 18 Mt COMP.

5050 48VDC

8W

LEDs/M 56
MIN CUT 250 mm
FPCB 16 mm



Light Color	Color Temperature/Wavelength(K/nm)	Beam Angle	Ra	Typical Luminous Flux(lm/m)	Efficacy (lm/w)	Voltage (DC V)	Power (W/m)
R	615-630	120°	--	70	37	48	1.92
G	515-530			201	98		1.92
B	460-470			38	20		1.92
WHITE	2871K-3045K			215	113		1.92
RGB				324	52		5.76
RGBW				536	65		7.68

C.1

COMPONENTES

FITAS LED

FITA LED
PARA GRANDES COMPRIMENTOS
LED STRIPS FOR LARGE LENGTHS

Waterproof IP67

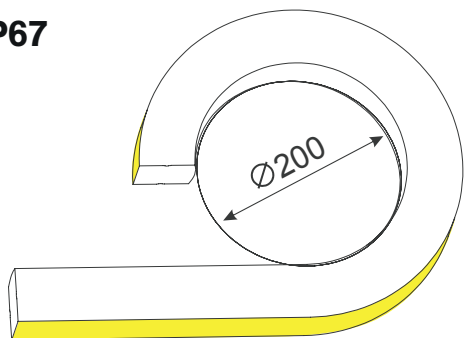
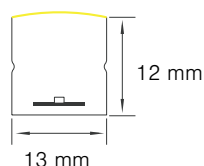

Light Surface

NEONFLEX 1312

20 metros com uma única ligação directa 48VDC



Corte min. 100 mm

TAMBÉM DISPONÍVEL EM 24VDC
CORTE MIN. 50 MM

2835 48VDC

9,6W

LEDs/M
120

MIN CUT
100 mm

FPCB
13X12 mm

3000
K

4000
K

Lm
650/m

CRI
90



FITA LED
PARA GRANDES COMPRIMENTOS
LED STRIPS FOR LARGE LENGTHS

Waterproof IP67

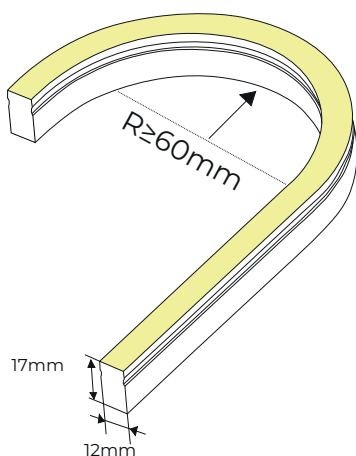
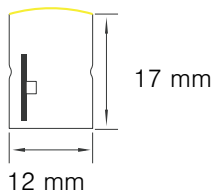

NEONFLEX 1217

20 metros com uma única ligação directa 48VDC



Corte min. 100 mm

TAMBÉM DISPONÍVEL EM 24VDC
CORTE MIN. 100 MM

2835 48VDC

9,6W

LEDs/M
120

MIN CUT
100 mm

FPCB
13X12 mm

3000
K

4000
K

Lm
390/m

CRI
90



COMPONENTES

FITAS LED

C.1

FITAS LED

PARA GRANDES COMPRIMENTOS

LED STRIPS FOR LARGE LENGTHS

230VAC 12W 1100LM

50 metros com uma única ligação directa AC

acessórios apropriados para Classe I

Fita flexível LED 2835, alimentação directa tensão de rede 230VDC, 108 leds/metro, revestimento manga de silicone, IP65, rolo com comprimento até 50 metros. Corte possível em segmentos com 25 cm. Alta eficiência, 104 Lm/watt (5700K), potência de 9,2 - 12W, fluxo regulável com reóstato. Temperatura de cor 3000, 4000K e 5700K, CRI>85.

Waterproof IP65

No Power supply

Low Flicker

48VDC 9W 985LM

25 metros com uma única fonte de alimentação

LED pitch : 9,6 mm

CORTE SEGMENTOS DE 250 MM

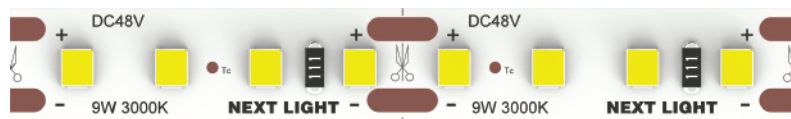

120LED / METRO

CORTE: 33.3mm

FLUX: 985 Lm

25 meters with a single power supply

LARGURA IP20: 10 mm

LARGURA IP65: 12 mm



C.1

COMPONENTES FITAS LED

8W 528 LEDS /metro

IP20	Código	Descrição	P.V.P. / MT
	FSCOF05	FITA COF 8W 2700K IP20 24V	18,20 €
	FSCOF03	FITA COF 8W 3000K IP20 24V	18,20 €
	FSCOF04	FITA COF 8W 4000K IP20 24V	18,20 €

5 mm CHIP ON FLEXIBLE PCB



10W 480 LEDS /metro

IP20	Código	Descrição	P.V.P. / MT
	FSCOF06	FITA COF 10W 2700K IP20 24V	15,15 €
	FSCOF01	FITA COF 10W 3000K IP20 24V	15,15 €
	FSCOF02	FITA COF 10W 4000K IP20 24V	15,15 €

8 mm CHIP ON FLEXIBLE PCB



12W 238 LEDS /metro

IP20	Código	Descrição	P.V.P. / MT
		FITA 2110 12W 2700K IP20 24V	
	FS08080	FITA 2110 12W 3000K IP20 24V	15,45 €
	FS08081	FITA 2110 12W 4000K IP20 24V	15,45 €

4MM PCB: 238 LED/MT >100 LM/W



5W 64 LEDS /metro



IP20	Código	Descrição	P.V.P. / MT	IP65	Código	Descrição	P.V.P. / MT
	FS02710	FITA 2835 5W 2700K IP20 24V	8,60 €		FS02712	FITA 2835 5W 2700K IP65 24V	11,10 €
	FS03030	FITA 2835 5W 3000K IP20 24V	8,60 €		FS03032	FITA 2835 5W 3000K IP65 24V	11,10 €
	FS03031	FITA 2835 5W 4000K IP20 24V	8,60 €		FS03027	FITA 2835 5W 4000K IP65 24V	11,10 €

10W 128 LEDS /metro



IP20	Código	Descrição	P.V.P. / MT	IP65	Código	Descrição	P.V.P. / MT
	FS02723	FITA 2835 10W 2700K IP20 24V	15,15 €		FS02725	FITA 2835 10W 2700K IP65 24V	17,85 €
	FS02702	FITA 2835 10W 3000K IP20 24V	15,15 €		FS02701	FITA 2835 10W 3000K IP65 24V	17,85 €
	FS02721	FITA 2835 10W 4000K IP20 24V	15,15 €		FS02722	FITA 2835 10W 4000K IP65 24V	17,85 €

14W 160 LEDS /metro



IP20	Código	Descrição	P.V.P. / MT	IP65	Código	Descrição	P.V.P. / M
	FS06063	FITA 2835 14W 2700K IP20 24V	19,99 €		FS06064	FITA 2835 14W 2700K IP65 24V	22,69 €
	FS06062	FITA 2835 14W 3000K IP20 24V	19,99 €		FS06060	FITA 2835 14W 3000K IP65 24V	22,69 €
	FS06061	FITA 2835 14W 4000K IP20 24V	19,99 €		FS06065	FITA 2835 14W 4000K IP65 24V	22,69 €

C.1

COMPONENTES

FITAS LED

17W RGB 120 LEDS /mt 24 VDC



IP20	Código	Descrição	P.V.P. / MT	IP65	Código	Descrição	P.V.P. / MT
	FS02704	FITA RGB 4040 16W IP20 24V	19,44 €		FS02705	FITA RGB 4040 16W IP65 24V	22,40 €

8W RGBW 56 LEDS /mt 48 VDC

IP20	Código	Descrição	P.V.P. / MT	IP65	Código	Descrição	P.V.P. / MT
	FS03531	FITA RGB 5050 8W IP20 48VDC	25,20 €		FS03532	FITA RGB 5050 8W IP65 48VDC	27,90 €

9W 120 LEDS /metro 48 VDC



IP20	Código	Descrição	P.V.P. / MT	IP65	Código	Descrição	P.V.P. / MT
	FS07010	FITA 2835 9W 2700K IP20 48V	15,50 €		FS07013	FITA 2835 9W 2700K IP65 48V	17,60 €
	FS07011	FITA 2835 9W 3000K IP20 48V	15,50 €		FS07014	FITA 2835 9W 3000K IP65 48V	17,60 €
	FS07012	FITA 2835 9W 4000K IP20 48V	15,50 €		FS07015	FITA 2835 9W 4000K IP65 48V	17,60 €

12W 120 LEDS /metro AC 230V

IP65	Código	Descrição	P.V.P. / MT
	C012001.14	FITA AC 2835 12W 2700K IP65 230VAC	23,40 €
	C012002.14	FITA AC 2835 12W 3000K IP65 230VAC	23,40 €
C012003.14	FITA AC 2835 12W 5700K IP65 230VAC	23,40 €	



10W 1312 NEONFLEX 48VDC

IP20	Código	Descrição	P.V.P. / MT
	FT1231	FITA NEONFLEX 1312 2700K IP67	26,20 €
	FT1221	FITA NEONFLEX 1312 3000K IP67	26,20 €
FT1222	FITA NEONFLEX 1312 4000K IP67	26,20 €	

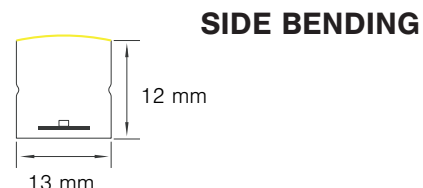

10W 1217 NEONFLEX 48VDC

IP20	Código	Descrição	P.V.P. / MT
	FT2113	FITA NEONFLEX 1217 2700K IP67	29,45 €
	FT1112	FITA NEONFLEX 1217 3000K IP67	29,45 €
FT2112	FITA NEONFLEX 1217 4000K IP67	29,45 €	

